

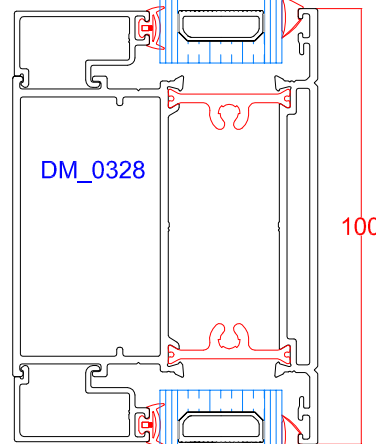







In side

Out side



Out side

-  DO_0345 Outer width and Height = -0
-  DSO_0343 Stile width = -67
Stile Height = -67
DD Rail = width / 2 - 37
-  DM_0328 Mid Rail = Top Rail - 144
-  DDA_0323 DD Adaptor = Door stile - 24
(Cut @ 4 Deg)
-  BV02 Door Bead (Open In 22952)
-  BV04 Bevel Bead
-  5014 Drip
-  WPC Wool pile Carrier

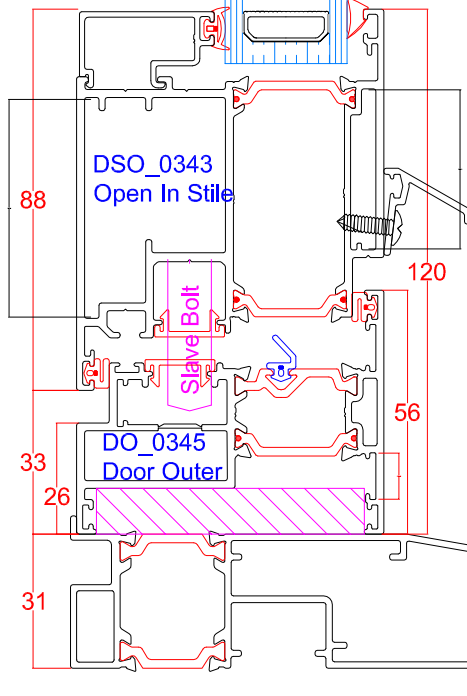

Glass width = -217
 Full Glass Height = -217
 Top Glass = Height - midrail from bottom -147
 Bottom Glass = Mid rail from bottom - 147
 DD Glass Width = Width / 2 - 188